

G A M E  R E A D Y™

VETERINARY CONTROL UNIT

User's Manual

MODEL 550450

*User's Manual also available online at
www.gamereadyveterinary.com*

T A B L E O F C O N T E N T S

The Game Ready Difference _____	3
Indications for Use _____	5
General Warnings and Precautions _____	5
General Warnings and Precautions _____	6
Device Classification _____	7
Description of Device _____	8
Using Your Game Ready System _____	11
Cleaning _____	16
Maintenance _____	17
Storage _____	17
Specifications _____	17
Accessories _____	17
Troubleshooting _____	18
Warranty _____	20

T H E G A M E R E A D Y D I F F E R E N C E

T H E G A M E R E A D Y D I F F E R E N C E

Game Ready™ was built upon the concept that the principles behind spacesuit technology could be used to develop an injury treatment system. As a designer for the National Aeronautics and Space Administration (NASA) and an inductee into the U.S. Space Foundation's Hall of Fame, our founder helped pioneer the technology involved in controlling pressure and temperature within a flexible garment. In 1998, we began working with athletes, athletic trainers, doctors, and veterinarians to expand breakthrough discoveries into the realm of sports medicine for both people and animals.

R E G I S T E R Y O U R P R O D U C T

Please complete your Warranty Registration for both the Game Ready Control Unit and the Wraps online at www.gamereadyveterinary.com. The Wrap registration card is packaged with the Heat Exchanger of each Wrap. You must register within 30 days from the date of purchase in order to receive warranty service.

Let us know what you think of our products. We'd love to hear from you.

Game Ready
CoolSystems Inc.
1201 Marina Village Pkwy, Suite 200
Alameda, CA 94501

**In the United States call toll-free:
1.888.GameReady
1.888.426.3732**

**Outside of the U.S. call:
001.510.868.2100**

www.gamereadyveterinary.com

INDICATIONS FOR USE

- Follow the recommendations of your veterinarian.

The Game Ready System combines cold and compression therapies. It is intended to prevent injuries, treat post-surgical and acute injuries to reduce edema, swelling, and pain where cold and compression are indicated.

GENERAL WARNINGS AND PRECAUTIONS

Thank you for choosing the Game Ready System. To assure you have the best experience possible, please be sure to read the entire User's Manual prior to use of the product.

WARNINGS

- Improper placement or prolonged use of Game Ready could result in tissue damage such as frostbite.
 - During the course of Game Ready therapy, the treatment provider should monitor the tissue surrounding the treated region or the extremities of the treated limb for any abnormal appearance, increased swelling, or pain. If any of these signs present, or any changes in skin appearance occur (such as increased redness, discoloration, or other noticeable skin changes), you are advised to discontinue use and consult a veterinarian.
- The Game Ready Wrap is not sterile; do not place directly against open wounds, sores, rashes, infections, or stitches. May be applied over dressing.
- The Game Ready wraps are available in multiple configurations but are not intended for all possible uses. Use caution when selecting a particular wrap for use on anatomic regions other than that for which the wrap is indicated and closely supervise the animal's status.
- To avoid the risk of electrical shock, do not remove any panels from the Control Unit. For all servicing and repair, please contact Game Ready Customer Service; from the U.S. call toll-free at 1.888.426.3732, from outside the U.S. call 001.510.868.2100. Opening the case will void the Game Ready warranty.
- To avoid the risk of electrical shock, always turn off the System and disconnect the power cord from its electrical outlet when not in use or before adding or emptying ice and water.
- Do not use any adapter other than that provided by Game Ready. Use of other adapters may result in electrical shock and will void the Game Ready warranty.

PRECAUTIONS

- Caution: This product is for veterinary use only and is not indicated for human use.
- Caution: Always attend the animal while the Game Ready Veterinary System is being used, in the case that the animal needs to be quickly disconnected from the Control Unit.
- Do not operate the System without any water in the ice box.
- Never operate the System with damaged power cords or Connector Hoses, or other mechanical damage, or if the unit is otherwise not fully operational.
- Do not pour hot water into the ice box. The System was not designed to operate, and has not been tested, with hot water.
- Do not pick up the Control Unit by the lid. Carry using the handle only.
- Do not use other manufacturers' wraps with the Game Ready System.
- Do not operate the Control Unit without a Connector Hose attached.
- Be careful not to trip over the System's power cords and Connector Hose, or use the product where these are likely to trip an animal.
- The Game Ready Control Unit is a veterinary medical device. **Handle it with the same care as you would a laptop computer.** Do not drop it, kick it or otherwise abuse it unnecessarily. Such abuse will void all Game Ready warranties. Do not place the AC Adapter or battery pack inside the ice box for storage or transport.

In addition to the precautions listed above, additional warnings and safety precautions are posted throughout this manual. Read and carefully follow these instructions prior to operating the System.

D E V I C E C L A S S I F I C A T I O N

Protection against electric shock (5.1):

The Game Ready System is considered to be Class I (protective earth) when connected to the Ault Model MW 128 power supply, and Class II (double insulated) when connected to the GlobTek Model GTM-21097-5012 power supply.

Protection against harmful ingress of water (5.3):

This product provides ordinary protection against ingress of water.





Degree of safety in the presence of flammable anesthetics or oxygen (5.5):

Not suitable for use in an oxygen enriched environment or in the presence of flammable anesthetics.

Electromagnetic interference:

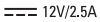
This equipment has been tested and found to comply with the limits for medical devices in IEC 60601-1-2:2001. These limits are designed to provide reasonable protection against harmful interference in a typical medical installation. This equipment generates, uses and can radiate radio frequency energy and, if not installed and used in accordance with the instructions, may cause harmful interference to other devices in the vicinity. However, there is no guarantee that interference will not occur in a particular installation. If this equipment does cause harmful interference to other devices, which can be determined by turning the equipment off and on, the user is encouraged to try to correct the interference by one or more of the following measures:

- Reorient or relocate the receiving device.
- Increase the separation between the equipment.
- Connect the equipment into an outlet on a circuit different from that to which the other device(s) are connected.
- Consult the manufacturer or field service technician for help.

 12V/2.5A	Powered by Direct Current
	Type BF Applied Parts
	Attention: Consult accompanying documents before use.
	Manufacturer

DESCRIPTION OF DEVICE

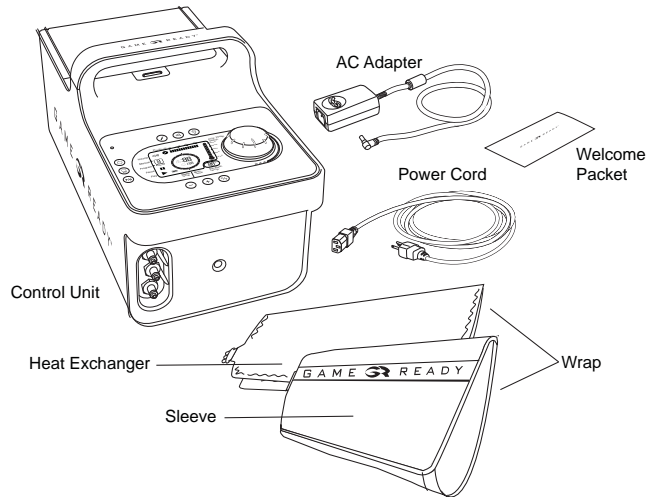

Game Ready System: The following items are included in your Game Ready System: a Control Unit, an AC Adapter, a Power Cord, and a Welcome Packet. In addition to these items, a Hose, Heat Exchanger and Sleeve are required to operate the system. These items may be purchased separately.

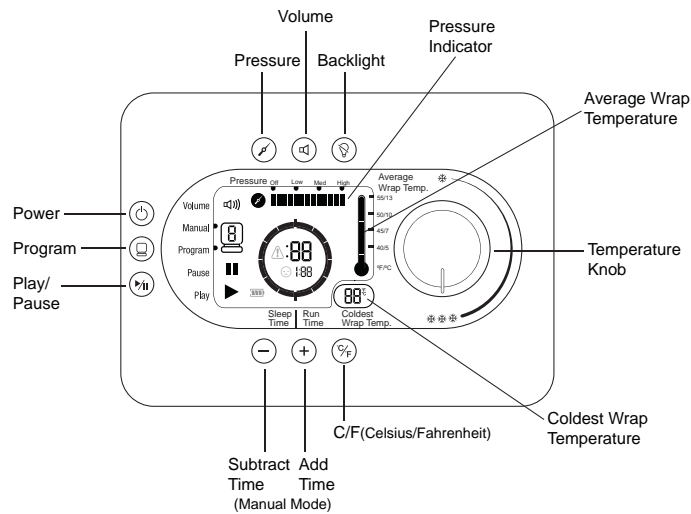

MODES OF OPERATION

Manual Mode: The System defaults to this mode, and allows the user to adjust time and pressure settings.

Program Mode: This mode allows the user to choose one of six programs that provide treatment for a set time then sleep (no treatment) for a set time, continuously, at a specific pressure setting.

Drain Mode: This mode allows a user to connect a Hose with a special Hose Adapter to the unit, enter Drain Mode and have the unit empty the water out of the ice box through the Hose. Drain Mode can be accessed by pressing the program key and toggling through all six programs. To empty water in the System while in Drain Mode, press the program key until you reach Drain Mode, attach the Hose Adapter to the Connector Hose, place the Hose Adapter over a sink, and press the play button. Drain Mode will run the Control Unit's fluid pump for up to six minutes (long enough to fully empty the ice box). Drain Mode is indicated by the following icons:



BUTTONS

	Power: Use this button to turn the Control Unit on and off.
	Program: Use this button to select one of the available Programs or to return to Manual Mode. See page 15 in this manual for more information on Programs.
	Play/Pause: Use this button to start or pause a treatment or to stop.
	Add Time: Use this button to add time in Manual Mode (does not work in Program Mode). You can add up to 90 minutes. Treatment must be paused in order to add or subtract time.
	Subtract Time: Use this button to reduce time in Manual Mode (does not work in Program Mode). You can subtract up to 90 minutes. Treatment must be paused in order to add or subtract time.
	Pressure Selection: Use this button to select one of four pressure settings: No Pressure, Low Pressure (5-15 mmHg), Medium Pressure (5-50 mmHg), and High Pressure (5-75 mmHg). Pressure selection is not available in Program Mode. Treatment must be paused to change pressure settings.
	Volume: Use this button to select the option of sound or no sound. Alarms will still sound.
	C/F Button: Use this button to select either Celsius or Fahrenheit on the temperature display.
	Backlight: Use this button to turn the backlight on or off.

Adjusting Temperature: The Control Unit cools the Wrap by pumping water from the ice box into the Wrap; therefore, the temperature of the Wrap will never be colder than the water in the ice box. If the knob is turned to three (3) snowflakes, the Control Unit will provide the coldest possible therapy based on the temperature of the water in the ice box. Turning the knob towards one (1) snowflake will provide less cold therapy.

Note: The unit should always be started on full cold (3 snowflakes), and run that way for at least two minutes. The user can then adjust temperature as desired.

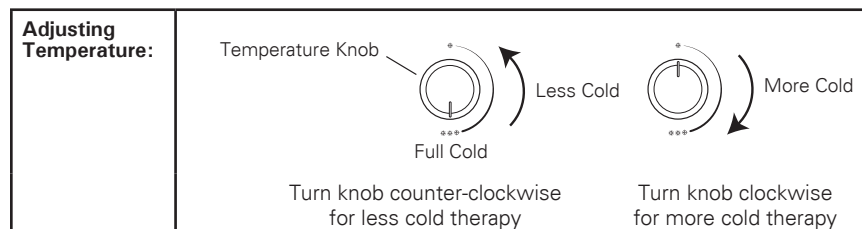

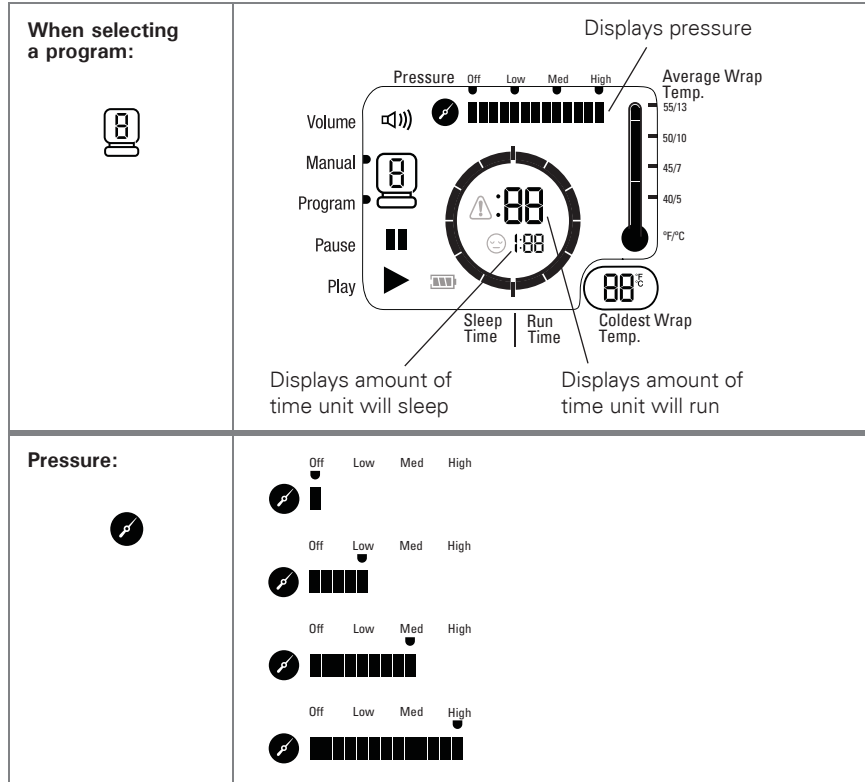

U S I N G Y O U R G A M E R E A D Y S Y S T E M

To operate your Game Ready System, you need:

- A Control Unit filled with ice and water
- A Game Ready supplied power supply
- A Connector Hose (Sold separately)
- A Wrap (a Heat Exchanger and Sleeve) (Sold separately)

Notes:

- The Wrap is comprised of an inner Heat Exchanger and an outer Sleeve. The combination of Sleeve and Heat Exchanger is referred to throughout this manual as a "Wrap."
- The Game Ready Control Unit should be placed on a stable surface (such as the floor or a table) during use.
- Please note that using the System in an environment with a high ambient temperature may affect its ability to provide adequate cooling, or may limit the ice life.
- If you will be using the System with a Game Ready supplied battery pack please consult the instructions for use that accompanied that battery pack for usage details.

Warning:

Position the Control Unit to minimize the risk of tripping over the Control Unit, Connector Hose or power cord.

USING YOUR GAME READY SYSTEM

Warning:

Your Game Ready Control Unit should be plugged into a grounded electrical outlet prior to operation.

Precautions:

- Failure to properly follow the set-up instructions may result in inadequate therapy.
- Unplug the Control Unit from the electrical outlet prior to filling the Control Unit with ice and water.

STEP 1: Push the door release button to open the ice box door.

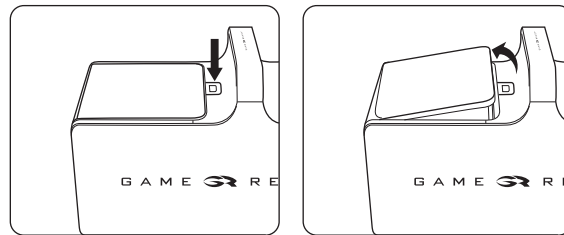

STEP 2: Fill the ice box completely with ice, and at least $\frac{1}{2}$ full with clean water.

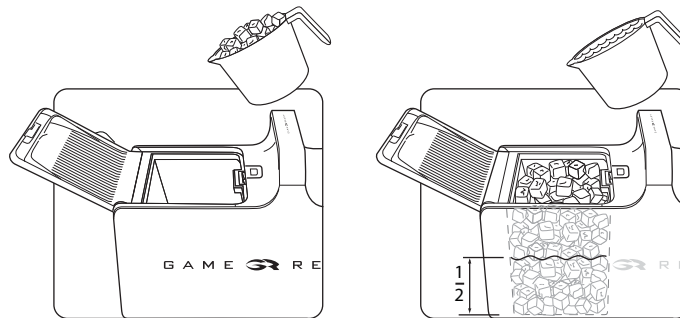

STEP 3: Close the ice box door. Make sure you hear it click.

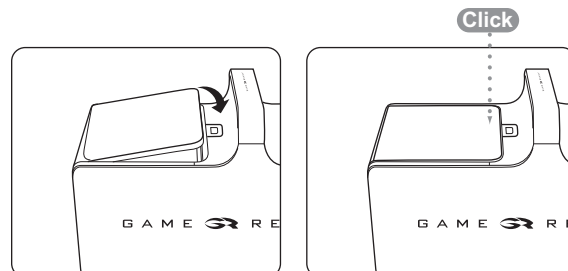

USING YOUR GAME READY SYSTEM

STEP 4: Place the Control Unit in the location where you plan to use it. The Control Unit should only be used in the upright orientation as shown. The Control Unit will leak if placed on its side.

STEP 5: Connect the AC Adapter to the Control Unit and the grounded electrical outlet. The power indicator light (orange color) on the Control Unit should illuminate. If it does not illuminate, check to make sure that the AC Adapter is firmly connected in all locations and that the outlet is receiving power. If necessary, try an alternate outlet or power supply. If the light is still not illuminated and the Control Unit will not turn on, please contact Game Ready Customer Service; from the U.S. call toll-free at 1.888.426.3732, or from outside of the U.S. call 001.510.868.2100.

Note: The Control Unit should be powered up prior to attaching a Wrap.

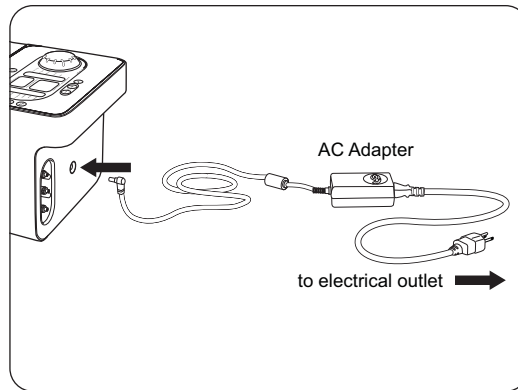

STEP 6: Connect the larger end of the Connector Hose to the Control Unit. Make sure you hear it click. To disconnect, simply press the button and remove the connector from its port.

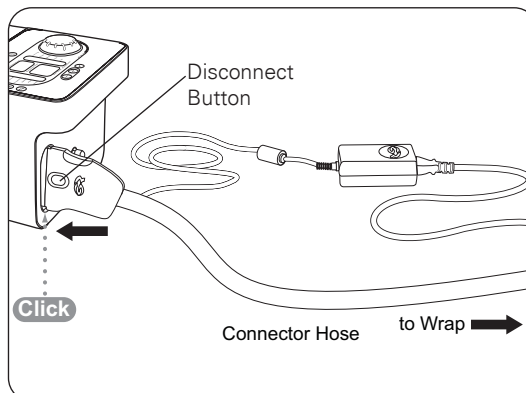

USING YOUR GAME READY SYSTEM

STEP 7: Apply the selected Wrap (consult the Use Guide for each Wrap for application instructions).

Warning: Do not place directly against open wounds, sores, rashes, infections, or stitches. May be applied over clothing or dressing.

Caution: If applying the same Wrap to another animal, make sure the Wrap is deflated before the next application.

STEP 8: Connect the smaller end of the Connector Hose to the Wrap. Make sure you hear it click. To disconnect, simply press the button and remove the connector from its port.

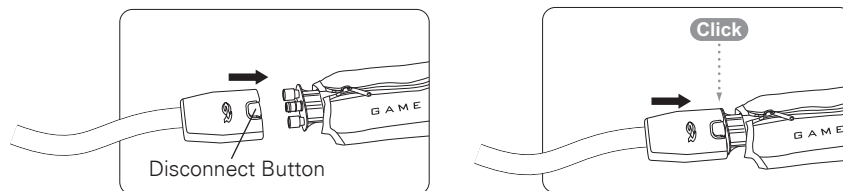

If you have any problems with the set-up of your Game Ready System, please contact Game Ready Customer Service; from the U.S. call Toll-free at 1.888.426.3732, from outside of the U.S. call 001.510.868.2100.

Warnings:

- Follow the recommendations of your veterinarian.
- Improper placement or prolonged use of Game Ready could result in tissue damage such as frostbite.
- For additional warnings and precautions, please refer to pages 5-6 of this manual.

STEP 9:  Press the power button. The screen should light up and the Control Unit should beep once. The power indicator light should turn from orange to green.

STEP 10:  Adjust the temperature by turning the temperature knob. Turning the knob right, toward 3 snowflakes, will provide more cold therapy. Turning the knob left, toward 1 snowflake, will provide less cold therapy.



U S I N G Y O U R G A M E R E A D Y S Y S T E M

STEP 11:



Manual ▶ 
 Program ▶ 

You can choose to operate in either Manual Mode or Program Mode. Manual Mode allows you to adjust time and pressure settings. Program Mode allows you to choose one of six programs that provide treatment for a set time then sleep (no treatment) for a set time, continuously, at a specific pressure setting. The unit will default to Manual Mode.

Manual Mode:

 	Set the time by pushing the +/- buttons.
	Set the pressure by pushing the pressure button. You can select from 4 pressure settings: No pressure, Low Pressure (5-15 mmHg), Medium Pressure (5-50 mmHg), High Pressure (5-75 mmHg).

Program Mode:

	Push the program button to enter Program Mode. In Program Mode, the unit will operate continuously according to the selected program. You will need to add ice periodically for optimal cooling.
	<p>You can select from the following programs: (Push the Program Button to scroll through the available programs.)</p> <p>Program 1: 30 minutes on, 30 minutes sleep. No pressure. Program 2: 30 minutes on, 30 minutes sleep. Low pressure. Program 3: 30 minutes on, 30 minutes sleep. Medium pressure. Program 4: 30 minutes on, 60 minutes sleep. No pressure. Program 5: 30 minutes on, 60 minutes sleep. Low pressure. Program 6: 30 minutes on, 60 minutes sleep. Medium pressure. Program d: Drain Mode. Please refer to page 9 in this manual for details.</p>

STEP 12:



Press play/pause button.

NOTE:

To operate the Game Ready System, you do not need to remove it from the Bag. Simply unzip the Bag's main compartment and end panel. Fill the ice box with ice and water. Attach the Connector Hose and the AC Adapter to the end panel of the Control Unit and plug the AC Adapter into an electrical outlet.

C L E A N I N G

CONTROL UNIT

The exterior of the Control Unit and the visible interior surfaces of the ice box can be cleaned with a soft cloth and one of the following cleaning agents:

- Mild detergent
- 5% Bleach solution
- 6% Hydrogen peroxide
- 70% Isopropyl alcohol

DO NOT USE

- Phenolic-based disinfectants (such as Amphyl).
- Quaternary Ammonium (such as Virex)
- Any solvent-based cleaners on the Control Unit. Doing so will damage the plastics and will void your warranty.
- Abrasive materials to clean the Control Unit. Doing so will damage the plastics and will void your warranty.

Caution: The Control Unit is not a waterproof device. Do not apply a direct stream of any liquid onto the Control Unit, submerge the Control Unit, or allow any liquid to pool on the surface of the front panel of the Control Unit.

Procedure:

- Follow the manufacturer's instructions and precautions for the cleaning agent you select.
- Apply the selected cleaner to a soft cloth and wipe down all surfaces of the Control Unit.
- Allow the Control Unit to dry thoroughly before storing it in the bag.
- The Control Unit should be cleaned as needed.

CONNECTOR HOSE

The Connector Hose can be cleaned using a soft cloth and one of the following:

- Mild detergent
- 70% Isopropyl alcohol

We do not recommend the use of Quaternary Ammonium (such as Virex).

DO NOT USE:

- Phenolic-based disinfectants (such as Amphyl).
- Any solvent based cleaners on the Connector Hose. Doing so will damage the plastics and will void your warranty.
- Abrasive materials to clean the Connector Hose. Doing so will damage the plastics and will void your warranty.
- Any petroleum based lubricants on the Connector Hose. Doing so will damage the o-rings and will void your warranty. If lubrication is required, the use of silicone spray is recommended. The following silicone sprays have been successfully tested with our o-rings:
 - DuPont Teflon Silicone Spray (DuPont Part# DS0614101)
 - 3M Silicone Spray (3M Part# 62-4678-4930-3)
 - 500 PSI Silicone Pump Spray (Game Ready Part# 302056)

WRAPS

Gently remove Heat Exchanger from the Sleeve. Hand wash the sleeve in cold water, using a mild detergent or antibacterial soap. Do not use fabric softener. Hang to dry.

If needed, the external surface of the Heat Exchanger may be cleaned by wiping down with commercial non-bleach cleaning wipes or hand washed using a very small amount of mild detergent or antibacterial soap. DO NOT MACHINE WASH. Periodically run Hydrogen Peroxide through your Game Ready System to keep the interior of your wrap clean.

Refer to the Wrap Use Guide for more specific Wrap care instructions.

C L E A N I N G C O N T I N U E D

CARRY BAG

The Carry Bag should be cleaned using a soft cloth or brush and a mild detergent. Febreze™ or the equivalent can be used on the Bag if desired. If the carry bag has a biological material on the surface, Sterifab™ may be used to decontaminate those surfaces.

Be sure to test any product on a small portion of the Bag to make sure that it will not damage the Bag.

M A I N T E N A N C E

Inspect and clean or replace the ice box filter as necessary. Remove the filter by rotating it counter clockwise. No product maintenance should be performed by the user. If your Game Ready System requires maintenance, please contact Game Ready Customer Service; from the U.S. call toll-free at 1.888.426.3732, from outside of the U.S. call 001.510.868.2100.

S T O R A G E

When you are done using the System for the day:

- Unplug the AC Adapter and the Connector Hose from the Control Unit.
- Push the door release button to open the door.
- Carefully dump the ice and water into the sink.
- Wipe off any excess water.
- Store the Control Unit in the Carry Bag or in another safe location. Store the Control Unit with the lid fully open to allow the interior to dry and preserve the ice box seal.
- Remember that your Game Ready Control Unit is a valuable piece of equipment and should be treated like a laptop computer, with great care.

Storage Temperature Conditions: 1° - 50° C (33° - 122° F)

Relative Humidity: 10% - 95% non-condensing

Caution: Do not keep in extreme hot or cold temperatures (above 122°F or below 33°F). Do not leave in a hot or freezing car. Do not leave the Control Unit in direct sunlight. The UV light may damage or discolor the Control Unit.

S P E C I F I C A T I O N S

Size: 16.25" length x 7.75" width x 9.25" height (413 x 197 x 235) mm, not including carrying case

Weight: 7.3 lb. empty, approximately 18 lb. full of ice and water

Pressure level: cycles from 5mm Hg up to 75mm Hg

AC power: 100-240 V~, 50-60 Hz, 1.0A





DC input: 12V/2.5 A

A C C E S S O R I E S





The Game Ready Control Unit can be used with any of the following accessories:

- Any Game Ready Wrap. Wraps made by any other manufacturer CANNOT be used with this system.
- A Game Ready supplied Power Supply (Ault Model MW128 or GlobTek Model GTM-21097-5012) and Hospital Grade Power Cord
- A Game Ready Connector Hose (Not included)
- A Game Ready Carry Bag
- A Game Ready supplied battery and charger

T R O U B L E S H O O T I N G

ERROR	WHAT DOES IT MEAN	WHAT CAN I DO?
 01	<p>Air Pressure Sensor: The Control Unit has detected a problem calibrating the pneumatic compression circuit on start-up.</p>	<ul style="list-style-type: none"> • This is most likely to occur if you have restarted the System with an inflated Wrap attached. • Detach the Wrap and try again.
 02	<p>Self-Test Error – Air Pump: The Control Unit has detected an electronic problem in the air circuit on start-up.</p>	<ul style="list-style-type: none"> • Disconnect the Wrap from the Control Unit. • Turn the Control Unit off and on again without a Wrap connected.
 04	<p>Dry Pump: The Control Unit has detected a dry pump. In order to prevent possible damage to the fluid pump, the unit will stop therapy.</p>	<ul style="list-style-type: none"> • Make sure there is water in the ice box. • Verify that the ice box filter is not clogged. • Make sure there are no kinks in the Wrap or Connector Hose. • Turn the Control Unit off and on again. • Disconnect and reconnect the hose from the Control Unit and the Wrap. • Prime the Wrap using the following steps: <ul style="list-style-type: none"> - Select “No Pressure.” - Attach the largest Wrap available. - Lay the Wrap open (not on the body). - Run the System for 1 minute. • Prime the System using the following steps: <ul style="list-style-type: none"> - Disconnect the hose from the Control Unit. - Now, look at the Wrap connection location on the Control Unit. On the top valve, push the white prong in so that it is even with the metal connector. - Make sure you are not fully covering the opening in the prong. - Push start, and water should squirt out of the valve. - Restart the System.
 06	<p>Over Pressure: Indicates that the Control Unit has exceeded the target pressure.</p>	<ul style="list-style-type: none"> • Turn the Control Unit off and back on. • Apply the same Wrap more tightly. • Apply a different Wrap.

T R O U B L E S H O O T I N G

ERROR	WHAT DOES IT MEAN	WHAT CAN I DO?
 07	Under Pressure: The Control Unit can't reach its target maximum compression. This often indicates that there is a leak in the pneumatic compression circuit, either in the Connector Hose, Wrap or Control Unit. Or it may occur because the hook and loop fastener on your Wrap has worn out.	<ul style="list-style-type: none"> • Make sure the Wrap is tightly applied. • Try using a different Wrap and Hose to isolate the problem.
 08	Deflation Error: The Control Unit has detected that the Wrap has not properly deflated.	<ul style="list-style-type: none"> • Turn the Control Unit off. • If there is air left in the Wrap, disconnect the Wrap from the Connector Hose and manually deflate the Wrap. • Reconnect the Hose to the Wrap and reapply the Wrap to the body. • Turn the Control Unit on and press play/pause.
 09	Pump Performance Error : The Control Unit has determined that the fluid pump may be working too hard. This could be caused by ice or debris in the fluid circuit. In order to prevent possible damage to the fluid pump, the unit will stop therapy.	<ul style="list-style-type: none"> • Turn the Control Unit off and back on again. • Check to see if the filter is clogged. • If that does not solve the problem turn the Control Unit off for 20 minutes (to let the pump cool down) before turning it on again to try again.
 10	Low Flow: Control Unit has detected an interruption in the water flow.	<ul style="list-style-type: none"> • Check all hose connections • Make sure there is water in the ice box. • Verify that the ice box filter is not clogged. • Make sure there are no kinks in the Wrap or Connector Hose. • Turn the Control Unit off and on again. • Disconnect and reconnect the hose from the Control Unit and the Wrap.
 12	Self-Test Error – Fluid Circuit: The Control Unit has detected an electronic problem in the fluid circuit on start-up.	<ul style="list-style-type: none"> • Disconnect the Wrap from the Control Unit. • Turn the Control Unit off and on again without a Wrap connected.
	Control Unit will not turn on:	<ul style="list-style-type: none"> • Check to make sure the AC Adapter is securely plugged into a working electrical outlet. • Press the power button again. If the orange LED on the control panel is illuminated, but the Control Unit will not turn on, call 1.888.426.3732 from the U.S. and from outside the U.S. dial 001.510.868.2100. If no orange or green light is illuminated, check that the electrical outlet has power.

WARRANTY

CoolSystems warrants that the Game Ready Control Unit, if properly used, will be free from defects in material and workmanship for a period of one (1) year after the date the Game Ready Control Unit was purchased. If the Game Ready Control Unit, which is the subject of this Limited Warranty, fails during the warranty period for reasons covered by this Limited Warranty, CoolSystems, at its options, will:

- REPAIR the Game Ready Control Unit OR
- REPLACE the Game Ready Control Unit with another Game Ready Control Unit.

THIS LIMITED WARRANTY AND ANY IMPLIED WARRANTIES THAT MAY EXIST UNDER STATE LAW APPLY ONLY TO THE ORIGINAL PURCHASER OF THE GAME READY CONTROL UNIT AND ARE NON-TRANSFERABLE.

Extent of Limited Warranty

This limited warranty does not cover damages due to external causes, including, without limitation, accident, usage not in accordance with product instructions, misuse, neglect, alteration or repair.

How to Obtain Warranty Service

To obtain warranty service please contact Game Ready Customer Service; from the U.S. call toll-free at 1.888.426.3732, from outside of the U.S. call 001.510.868.2100. You must have returned the Warranty Registration card to CoolSystems within thirty (30) days from the date of purchase to qualify for warranty service. If you qualify for warranty service from CoolSystems, you will be issued a Returned Material Authorization (RMA) number. When you return the Game Ready Control Unit to CoolSystems, you must write the RMA number on the outside of the package. CoolSystems will not accept returned Game Ready Control Units without an RMA number on the package. If you return the Game Ready Control Unit to CoolSystems, you must assume the risk of damage or loss during shipping. You must use the original packaging or the equivalent. CoolSystems may require you to verify in writing that you are the original purchaser of the Game Ready Control Unit. CoolSystems may elect to replace or repair the Game Ready Control Unit with either a new or reconditioned product. The returned product shall become CoolSystems' property upon receipt. The replacement Game Ready Control Unit is warranted under this written warranty and is subject to the same limitations and exclusions for the remainder of the original warranty period. THIS WARRANTY IS NOT TRANSFERABLE.

WARRANTY LIMITATIONS AND EXCLUSIONS

THESE WARRANTIES REPLACE ALL OTHER WARRANTIES, EXPRESS OR IMPLIED INCLUDING, BUT NOT LIMITED TO, THE IMPLIED WARRANTIES OF MERCHANTABILITY AND FITNESS FOR A PARTICULAR PURPOSE. COOLSYSTEMS MAKES NO EXPRESS WARRANTIES BEYOND THOSE STATED HERE. COOLSYSTEMS DISCLAIMS ALL OTHER WARRANTIES, EXPRESS OR IMPLIED INCLUDING, WITHOUT LIMITATION, IMPLIED WARRANTIES OF MERCHANTABILITY AND FITNESS FOR A PARTICULAR PURPOSE. SOME JURISDICTIONS DO NOT ALLOW THE EXCLUSION OF IMPLIED WARRANTIES SO THIS LIMITATION MAY NOT APPLY TO YOU. ALL EXPRESS AND IMPLIED WARRANTIES ARE LIMITED IN DURATION TO THE LIMITED WARRANTY PERIOD. NO WARRANTIES APPLY AFTER THAT PERIOD. SOME JURISDICTIONS DO NOT ALLOW LIMITATIONS ON HOW LONG AN IMPLIED WARRANTY LASTS, SO THIS LIMITATION MAY NOT APPLY TO YOU.

WARRANTY

LIMITATIONS OF LIABILITY

COOLSYSTEMS' RESPONSIBILITY UNDER THIS, OR ANY OTHER WARRANTY, IMPLIED OR EXPRESS, IS LIMITED TO REPAIR OR REPLACEMENT, AS SET FORTH ABOVE. THESE REMEDIES ARE THE SOLE AND EXCLUSIVE REMEDIES FOR ANY BREACH OF WARRANTY. COOLSYSTEMS IS NOT RESPONSIBLE FOR DIRECT, SPECIAL, INCIDENTAL, OR CONSEQUENTIAL DAMAGES RESULTING FROM ANY BREACH OF WARRANTY OR UNDER ANY OTHER LEGAL THEORY INCLUDING, BUT NOT LIMITED TO, LOST PROFITS, DOWNTIME, GOODWILL, AND DAMAGE TO OR REPLACEMENT OF EQUIPMENT AND PROPERTY. SOME JURISDICTIONS DO NOT ALLOW THE EXCLUSION OR LIMITATION OF INCIDENTAL OR CONSEQUENTIAL DAMAGES, SO THE ABOVE LIMITATIONS OR EXCLUSIONS MAY NOT APPLY TO YOU.

THIS LIMITED WARRANTY GIVES YOU SPECIFIC RIGHTS, AND YOU MAY ALSO HAVE OTHER RIGHTS THAT VARY FROM JURISDICTION TO JURISDICTION.

WARRANTY REGISTRATION

Please complete the Warranty Registration for both the Game Ready Control Unit and the Wraps online at www.gamereadyveterinary.com. You must register within 30 days from the date of purchase in order to receive warranty service.

You will need the following information to complete your Warranty Registration:

The Control Unit's model number (REF) and its serial number (SN). These numbers are located on the label on the bottom of the Control Unit. Simply go to www.gamereadyveterinary.com, click on the Product Registration link at the top of the page, fill out and submit your information.

Extended Warranties

Extended Warranties are available for the Game Ready System. For details and information please contact Game Ready Customer Service; from the U.S. call toll-free at 1.888.426.3732, from outside of the U.S. call 001.510.868.2100.

